

# Micron TRUE Planetary® Gearheads

## XTRUE™

### True Planetary Gearheads

Ready for Immediate Delivery	
Precision	13 arc-minutes
Frame Sizes	40 mm, 50 mm, 60 mm, 70 mm , 80 mm, 90 mm, 120 mm and 160 mm
Torque Capacity	up to 876 Nm
Ratio Availability	3:1 thru 100:1
Radial load capacity	up to 3730 N
Mounting System	RediMount™

- 1 Sealed deep groove ball bearings**  
provide high radial load carrying capability
- 2 HRC 55-60 steel gears**  
provide superior wear resistance  
and increased backlash integrity
- 3 Sealed deep groove ball bearing**  
provides precision alignment of sun gear
- 4 RediMount™ system**  
provides error-free motor installation
- 5 Anodized aluminum housing**  
reduces weight and prevents corrosion

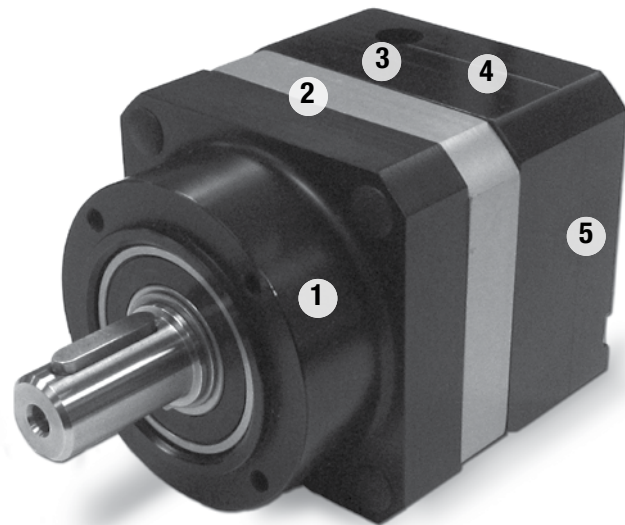

**Micron True Planetary® Gearheads  
shipped within 24 hours!**



**Need it fast? Go to the back cover  
of the catalog for details.**

## True Planetary Gearheads

### Introduction

The XTRUE Series is a new precision gearhead that complements our True Planetary gearhead line, already the largest selection of planetary gearheads in the world.

### Features and Benefits

- Frame sizes (8): 40mm, 50 mm, 60mm, 70 mm, 80mm, 90 mm, 120mm and 160mm
- Precision: 13 arc-mins
- Torque capacity: up to 876 Nm
- Ratio availability: 3:1 thru 100:1
- Move a larger load more easily and quietly with True Planetary gearing through improved load capacity, lower backlash and quieter operation.
- Experience less downtime with the flexible mounting system: RediMount system mounts to any motor in three easy steps: align, mount and tighten.
- Simplify replacement with the tapped face output, which enables easy drop-in replacement.
- Go green on your machine when the assembly and all components meet EU Directive 2002/95/EC (RoHS)

# Micron TRUE Planetary® Gearheads

## XTRUE™

### True Planetary Gearheads

XT

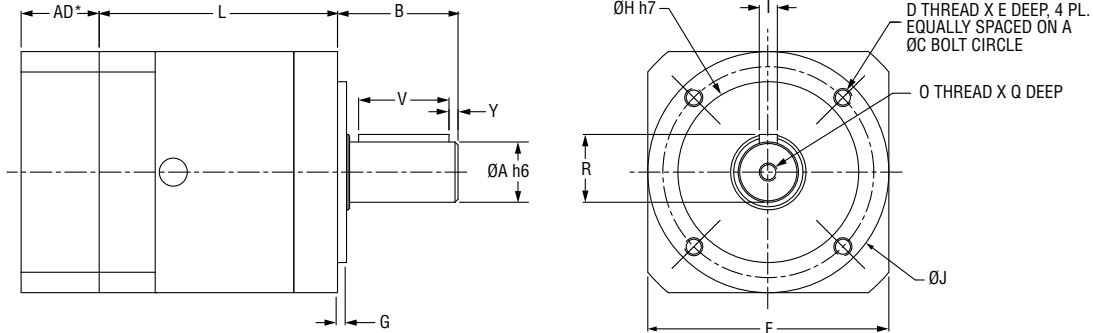

\*AD = Adapter Length  
Adapter Length will vary depending on motor. Consult customer service for details.

### Dimensions

Part Number	A Output Shaft Diameter mm [in.]	B Output Shaft Length mm [in.]	Y Shaft End Distance mm [in.]	V Keyway Length mm [in.]	R Keyway Height mm [in.]	I Key Width mm [in.]	H Pilot Diameter mm [in.]	J Body Diameter mm [in.]	G Pilot Length mm [in.]
XT040	10 [0.39]	26 [1.02]	2.5 [0.10]	18 [0.71]	11.2 [0.44]	3 [0.12]	26 [1.02]	40 [1.57]	2 [0.08]
XT060	14 [0.55]	35 [1.37]	2.5 [0.10]	25 [0.98]	16 [0.63]	5 [0.20]	40 [1.57]	60 [2.36]	3 [0.12]
XT080	20 [0.79]	40 [1.57]	4.0 [0.16]	28 [1.10]	22.5 [0.89]	6 [0.24]	60 [2.36]	80 [3.15]	3 [0.12]
XT120	25 [0.98]	55 [2.16]	5.0 [0.20]	40 [1.57]	28 [1.10]	8 [0.31]	80 [3.15]	115 [4.53]	4 [0.16]
XT160	40 [1.57]	87 [3.42]	8.0 [0.32]	65 [2.55]	43 [1.69]	12 [0.47]	130 [5.12]	160 [6.30]	5 [0.20]

### Dimensions

Part Number	D Thread	E Thread Depth mm [in.]	O Output Shaft Thread	Q Thread Depth mm [in.]	F Flange Square mm [in.]	L Length mm [in.]		C Bolt Circle mm [in.]
						3:1 - 10:1	15:1 - 100:1	
XT040	M4	6 [0.24]	M3	9 [0.35]	42 [1.65]	36.5 [1.43]	49.5 [1.94]	34 [1.34]
XT060	M5	8 [0.31]	M5	12 [0.47]	61 [2.40]	51 [2.00]	68 [2.67]	52 [2.05]
XT080	M6	10 [0.39]	M6	16 [0.63]	90 [3.54]	67 [2.64]	90 [3.54]	70 [2.76]
XT120	M10	16 [0.63]	M10	22 [0.87]	119 [4.53]	87.3 [3.44]	179 [4.67]	100 [3.94]
XT160	M12	20 [0.79]	M16	36 [1.42]	142 [5.59]	119.6 [4.71]	168.9 [6.65]	145 [5.71]

### Specifications

Part Number	Stages	Backlash (arc-min)	Efficiency	Weight		Ratio Availability
				kg	[lbs.]	
XT040	1	13	93%	0.45	[1.0]	3:1, 4:1, 5:1, 7:1, 10:1
	2	15	88%	0.5	[1.1]	15:1, 20:1, 25:1, 30:1, 40:1, 50:1, 70:1, 100:1
XT060	1	13	93%	1.0	[2.2]	3:1, 4:1, 5:1, 7:1, 10:1
	2	15	88%	1.2	[2.6]	15:1, 20:1, 25:1, 30:1, 40:1, 50:1, 70:1; 100:1
XT080	1	13	93%	3.0	[6.6]	3:1, 4:1, 5:1, 7:1, 8:1; 10:1
	2	15	88%	3.7	[8.1]	15:1, 20:1, 25:1, 30:1, 40:1, 50:1, 70:1, 80:1, 100:1
XT120	1	13	93%	5.7	[12.5]	3:1, 4:1, 5:1, 7:1, 10:1
	2	15	88%	7.3	[16.1]	15:1, 20:1, 25:1, 30:1, 40:1, 50:1, 70:1, 100:1
XT160	1	13	93%	12.8	[28.2]	3:1, 4:1, 5:1, 7:1; 10:1
	2	15	88%	17.2	[37.8]	15:1, 20:1, 25:1, 30:1, 40:1, 50:1, 70:1, 100:1

Specifications subject to change without notice.

### True Planetary Gearheads

XTA

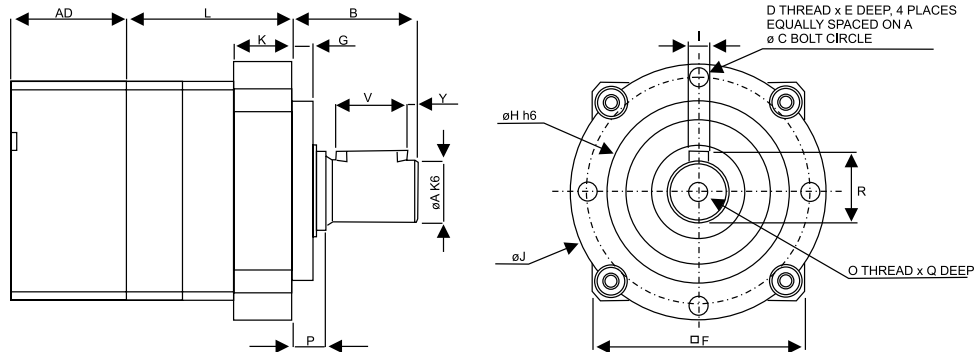

\*AD = Adapter Length  
Adapter Length will vary depending on motor. Consult customer service for details.

### Dimensions

Part Number	A Output Shaft Diameter mm [in.]	B Output Shaft Length mm [in.]	Y Shaft End Distance mm [in.]	V Keyway Length mm [in.]	R Keyway Height mm [in.]	I Key Width mm [in.]	H Pilot Diameter mm [in.]	J Output Body Diameter mm [in.]	G Pilot Length mm [in.]
XTA050	12 [0.47]	24.5 [0.97]	2 [0.079]	14 [0.55]	13.5 [0.53]	4 [0.16]	35 [1.38]	50 [1.97]	4 [0.16]
XTA070	16 [0.79]	36 [1.42]	2 [0.079]	25 [0.98]	18 [0.71]	5 [0.20]	52 [2.05]	70 [2.76]	5 [0.20]
XTA090	22 [0.87]	46 [1.81]	2 [0.079]	32 [1.26]	24.5 [0.96]	6 [0.24]	68 [2.68]	90 [3.54]	5 [0.20]
XTA120	32 [1.26]	70 [2.76]	4 [0.16]	50 [1.97]	35 [1.39]	10 [0.40]	90 [3.54]	120 [4.72]	6 [0.24]

### Dimensions

Part Number	D Output Housing Thread	E Thread Depth mm [in.]	O Output Shaft Thread	Q Thread Depth mm [in.]	F Square Size mm [in.]	K Output Body Length mm [in.]	L Length mm [in.]		C Bolt Circle mm [in.]
							3:1 - 10:1	15:1 - 100:1	
XTA050	M4x0.7-6H	8 [0.32]	M4x0.7-6H	8 [0.32]	42 [1.65]	11.7 [0.46]	33 [1.29]	46 [1.80]	44 [1.73]
XTA070	M5x0.8-6H	10 [0.40]	M5x0.8-6H	10 [0.40]	61 [2.40]	34.1 [1.34]	49 [1.93]	66.5 [2.62]	62 [2.44]
XTA090	M6x1.0-6H	12 [0.47]	M8x1.25-6H	13 [0.51]	90 [3.54]	24.5 [0.96]	65 [2.55]	87.5 [3.45]	80 [3.15]
XTA120	M8x1.25-6H	16 [0.63]	M12x1.75-6H	22 [0.87]	115 [4.53]	33.1 [1.30]	85.5 [3.36]	117 [4.60]	108 [4.25]

### Specifications

Part Number	Stages	Backlash (arc-min)	Efficiency	Weight		Ratio Availability
				kg	[lbs.]	
XTA050	1	13	93%	0.45	[1.0]	3:1, 4:1, 5:1, 7:1, 10:1
	2	15	88%	0.5	[1.1]	15:1, 20:1, 25:1, 30:1, 40:1, 50:1, 70:1, 100:1
XTA070	1	13	93%	1.0	[2.2]	3:1, 4:1, 5:1, 7:1, 10:1
	2	15	88%	1.2	[2.6]	15:1, 20:1, 25:1, 30:1, 40:1, 50:1, 70:1, 100:1
XTA090	1	13	93%	3.0	[6.6]	3:1, 4:1, 5:1, 7:1, 8:1, 10:1
	2	15	88%	3.7	[8.1]	15:1, 20:1, 25:1, 30:1, 40:1, 50:1, 70:1, 80:1, 100:1
XTA120	1	13	93%	5.7	[12.5]	3:1, 4:1, 5:1, 7:1, 10:1
	2	15	88%	7.3	[16.1]	15:1, 20:1, 25:1, 30:1, 40:1, 50:1, 70:1, 100:1

Specifications subject to change without notice.

# Micron TRUE Planetary® Gearheads

**XTRUE™**

True Planetary Gearheads

## Performance Specifications

Part Number	Ratio	20000 Hour Life				T <sub>peak</sub> Nm [in.-lb.]	J kg-cm <sup>2</sup> [in.-lb.-sec <sup>2</sup> *10 <sup>-4</sup> ]	Torsional Stiffness Nm/arc-min [in.-lb./arc-min]	
		T <sub>r</sub> (1000 rpm) Nm [in.-lb.]	T <sub>r</sub> (2000 rpm) Nm [in.-lb.]	T <sub>r</sub> (3000 rpm) Nm [in.-lb.]	T <sub>r</sub> (4000 rpm) Nm [in.-lb.]				
XT040	XT040-003	3:1	5.2 [46]	4.2 [37]	3.7 [33]	3.4 [30]	15.6 [138]	0.078 [0.690]	0.7 [6.2]
	XT040-004	4:1	5.54 [49]	4.41 [39]	3.95 [35]	3.62 [32]	16.5 [146]	0.057 [0.51]	0.7 [6.2]
	XT040-005	5:1	6.1 [54]	5.3 [47]	3.6 [32]	4.3 [38]	18.3 [162]	0.048 [0.425]	0.7 [6.2]
	XT040-007	7:1	6.1 [54]	4.97 [44]	4.41 [39]	4.07 [36]	18.3 [162]	0.042 [0.37]	0.7 [6.2]
	XT040-010	10:1	5.8 [51]	4.6 [41]	4.1 [36]	3.7 [33]	17.2 [152]	0.038 [0.336]	0.7 [6.2]
	XT040-015	15:1	8.4 [74]	6.8 [60]	6.0 [53]	5.5 [49]	25.2 [223]	0.045 [0.398]	0.7 [6.2]
	XT040-020	20:1	8.93 [79]	7.23 [64]	6.44 [57]	5.88 [52]	26.66 [236]	0.045 [0.398]	0.7 [6.2]
	XT040-025	25:1	9.3 [82]	7.6 [67]	6.7 [59]	6.1 [54]	27.8 [246]	0.045 [0.398]	0.7 [6.2]
	XT040-030	30:1	9.5 [84]	8.4 [74]	7.5 [66]	6.8 [60]	28.6 [253]	0.037 [0.328]	0.7 [6.2]
	XT040-040	40:1	10.96 [97]	8.93 [79]	7.91 [70]	7.23 [64]	32.88 [291]	0.037 [0.328]	0.7 [6.2]
	XT040-050	50:1	11.3 [100]	9.3 [82]	8.2 [73]	7.6 [67]	33.8 [299]	0.037 [0.328]	0.7 [6.2]
XT040-070	70:1	10.51 [93]	9.94 [88]	8.81 [78]	8.02 [71]	31.52 [279]	0.037 [0.328]	0.7 [6.2]	
XT040-100	100:1	8.1 [72]	7.5 [66]	7.1 [63]	6.9 [61]	24.4 [216]	0.040 [0.354]	0.7 [6.2]	
XTA050	XTA050-003	3:1	5.2 [46]	4.2 [37]	3.7 [33]	3.4 [30]	15.6 [138]	0.077 [0.682]	0.7 [6.2]
	XTA050-004	4:1	5.54 [49]	4.41 [39]	3.95 [35]	3.62 [32]	16.5 [146]	0.057 [0.50]	0.7 [6.2]
	XTA050-005	5:1	6.1 [54]	5.3 [47]	3.6 [32]	4.3 [38]	18.3 [162]	0.048 [0.425]	0.7 [6.2]
	XTA050-007	7:1	6.1 [54]	4.97 [44]	4.41 [39]	4.07 [36]	18.3 [162]	0.042 [0.37]	0.7 [6.2]
	XTA050-010	10:1	5.8 [51]	4.6 [41]	4.1 [36]	3.7 [33]	17.2 [152]	0.038 [0.336]	0.7 [6.2]
	XTA050-015	15:1	8.4 [74]	6.8 [60]	6.0 [53]	5.5 [49]	25.2 [223]	0.045 [0.398]	0.7 [6.2]
	XTA050-020	20:1	8.93 [79]	7.23 [64]	6.44 [57]	5.88 [52]	26.66 [236]	0.045 [0.398]	0.7 [6.2]
	XTA050-025	25:1	9.3 [82]	7.6 [67]	6.7 [59]	6.1 [54]	27.8 [246]	0.045 [0.398]	0.7 [6.2]
	XTA050-030	30:1	9.5 [84]	8.4 [74]	7.5 [66]	6.8 [60]	28.6 [253]	0.037 [0.328]	0.7 [6.2]
	XTA050-040	40:1	10.96 [97]	8.93 [79]	7.91 [70]	7.23 [64]	32.88 [291]	0.037 [0.328]	0.7 [6.2]
	XTA050-050	50:1	11.3 [100]	9.3 [82]	8.2 [73]	7.6 [67]	33.8 [299]	0.037 [0.328]	0.7 [6.2]
XTA050-070	70:1	10.51 [93]	9.94 [88]	8.81 [78]	8.02 [71]	31.52 [279]	0.037 [0.328]	0.7 [6.2]	
XTA050-100	100:1	8.1 [72]	7.5 [66]	7.1 [63]	6.9 [61]	24.4 [216]	0.040 [0.354]	0.7 [6.2]	
XT060	XT060-003	3:1	16 [139]	13 [112]	12 [102]	11 [93]	55 [483]	0.52 [4.6]	1.8 [15.9]
	XT060-004	4:1	20 [177]	17 [149]	15 [130]	14 [121]	46 [409]	0.46 [4.1]	1.8 [15.9]
	XT060-005	5:1	18 [158]	15 [130]	13 [112]	12 [102]	48 [427]	0.46 [4.1]	1.8 [15.9]
	XT060-007	7:1	17 [149]	14 [121]	12 [102]	11 [93]	43 [381]	0.46 [4.1]	1.8 [15.9]
	XT060-010	10:1	16 [139]	15 [130]	14 [121]	13 [112]	47 [418]	0.44 [3.9]	1.8 [15.9]
	XT060-015	15:1	26 [232]	21 [186]	19 [167]	17 [149]	55 [483]	0.46 [4.1]	1.8 [15.9]
	XT060-020	20:1	27 [242]	25 [223]	22 [195]	21 [186]	48 [427]	0.46 [4.1]	1.8 [15.9]
	XT060-025	25:1	25 [223]	23 [204]	20 [177]	19 [167]	55 [483]	0.46 [4.1]	1.8 [15.9]
	XT060-030	30:1	29 [260]	26 [232]	23 [204]	21 [186]	55 [483]	0.46 [4.1]	1.8 [15.9]
	XT060-040	40:1	28 [251]	27 [242]	27 [242]	25 [223]	48 [427]	0.44 [3.9]	1.8 [15.9]
	XT060-050	50:1	26 [232]	25 [223]	25 [223]	23 [204]	55 [483]	0.44 [3.9]	1.8 [15.9]
XT060-070	70:1	25 [223]	24 [214]	24 [214]	22 [195]	48 [427]	0.44 [3.9]	1.8 [15.9]	
XT060-100	100:1	21 [186]	20 [177]	19 [167]	18 [158]	43 [381]	0.44 [3.9]	1.8 [15.9]	

All ratios in frame size 060, 070, 080, 090, 120 and 160 are available to ship in 24 hours through the Gearhead Express Program.

T<sub>r</sub> = Rated output torque at rated speed for specific hours of life.  
T<sub>peak</sub> = Allowable momentary peak torque for emergency stop or heavy shock loading.  
J = Mass moment of inertia reflected to the input shaft (including pinion assembly).  
Specifications subject to change without notice.

### True Planetary Gearheads

Performance Specifications									
Part Number	Ratio	20000 Hour Life				T <sub>peak</sub> Nm [in.-lb.]	J kg-cm <sup>2</sup> [in.-lb.-sec <sup>2</sup> *10 <sup>-4</sup> ]	Torsional Stiffness Nm/arc-min [in.-lb./arc-min]	
		T <sub>r</sub> (1000 rpm) Nm [in.-lb.]	T <sub>r</sub> (2000 rpm) Nm [in.-lb.]	T <sub>r</sub> (3000 rpm) Nm [in.-lb.]	T <sub>r</sub> (4000 rpm) Nm [in.-lb.]				
XTA070	XTA070-003	3:1	16 [139]	13 [112]	12 [102]	11 [93]	55 [483]	0.458 [4.054]	1.8 [15.9]
	XTA070-004	4:1	20 [177]	17 [149]	15 [130]	14 [121]	46 [409]	0.360 [3.168]	1.8 [15.9]
	XTA070-005	5:1	18 [158]	15 [130]	13 [112]	12 [102]	48 [427]	0.322 [2.850]	1.8 [15.9]
	XTA070-007	7:1	17 [149]	14 [121]	12 [102]	11 [93]	43 [381]	0.282 [2.496]	1.8 [15.9]
	XTA070-010	10:1	16 [139]	15 [130]	14 [121]	13 [112]	47 [418]	0.262 [2.319]	1.8 [15.9]
	XTA070-015	15:1	26 [232]	21 [186]	19 [167]	17 [149]	55 [483]	0.305 [2.699]	1.8 [15.9]
	XTA070-020	20:1	27 [242]	25 [223]	22 [195]	21 [186]	48 [427]	0.304 [2.691]	1.8 [15.9]
	XTA070-025	25:1	25 [223]	23 [204]	20 [177]	19 [167]	55 [483]	0.303 [2.682]	1.8 [15.9]
	XTA070-030	30:1	29 [260]	26 [232]	23 [204]	21 [186]	55 [483]	0.258 [2.283]	1.8 [15.9]
	XTA070-040	40:1	28 [251]	27 [242]	27 [242]	25 [223]	48 [427]	0.257 [2.275]	1.8 [15.9]
XTA080	XTA080-003	3:1	59 [520]	48 [427]	43 [381]	39 [344]	165 [1459]	2.2 [19.5]	5.4 [47.8]
	XTA080-004	4:1	70 [623]	58 [511]	53 [465]	48 [427]	165 [1459]	1.8 [15.9]	5.4 [47.8]
	XTA080-005	5:1	65 [576]	53 [465]	47 [418]	43 [381]	165 [1459]	1.8 [15.9]	5.4 [47.8]
	XTA080-007	7:1	63 [558]	50 [446]	45 [400]	40 [353]	165 [1459]	1.7 [15.0]	5.4 [47.8]
	XTA080-008	8:1	62 [549]	49 [434]	45 [398]	42 [372]	165 [1460]	1.6 [14.2]	5.4 [47.8]
	XTA080-010	10:1	54 [474]	48 [427]	45 [400]	43 [381]	165 [1459]	1.8 [15.9]	5.4 [47.8]
	XTA080-015	15:1	90 [799]	78 [688]	69 [613]	63 [558]	175 [1552]	1.8 [15.9]	5.4 [47.8]
	XTA080-020	20:1	92 [818]	88 [781]	81 [716]	75 [660]	175 [1552]	1.5 [13.3]	5.4 [47.8]
	XTA080-025	25:1	87 [771]	83 [734]	76 [669]	69 [613]	175 [1552]	1.7 [15.0]	5.4 [47.8]
	XTA080-030	30:1	100 [883]	90 [799]	85 [753]	78 [688]	175 [1552]	1.7 [15.0]	5.4 [47.8]
XTA090	XTA090-003	3:1	59 [520]	48 [427]	43 [381]	39 [344]	165 [1459]	2.065 [18.277]	5.4 [47.8]
	XTA090-004	4:1	70 [623]	58 [511]	53 [465]	48 [427]	165 [1459]	1.621 [14.347]	5.4 [47.8]
	XTA090-005	5:1	65 [576]	53 [465]	47 [418]	43 [381]	165 [1459]	1.400 [12.391]	5.4 [47.8]
	XTA090-007	7:1	63 [558]	50 [446]	45 [400]	40 [353]	165 [1459]	1.193 [10.559]	5.4 [47.8]
	XTA090-008	8:1	62 [549]	49 [434]	45 [398]	42 [372]	165 [1460]	1.156 [10.231]	5.4 [47.8]
	XTA090-010	10:1	54 [474]	48 [427]	45 [400]	43 [381]	165 [1459]	1.118 [9.895]	5.4 [47.8]
	XTA090-015	15:1	90 [799]	78 [688]	69 [613]	63 [558]	175 [1552]	1.329 [11.763]	5.4 [47.8]
	XTA090-020	20:1	92 [818]	88 [781]	81 [716]	75 [660]	175 [1552]	1.319 [11.674]	5.4 [47.8]
	XTA090-025	25:1	87 [771]	83 [734]	76 [669]	69 [613]	175 [1552]	1.319 [11.674]	5.4 [47.8]
	XTA090-030	30:1	100 [883]	90 [799]	85 [753]	78 [688]	175 [1552]	1.100 [9.736]	5.4 [47.8]

All ratios in frame size 060, 070, 080, 090, 120 and 160 are available to ship in 24 hours through the Gearhead Express Program.

T<sub>r</sub> = Rated output torque at rated speed for specific hours of life.  
 T<sub>peak</sub> = Allowable momentary peak torque for emergency stop or heavy shock loading.  
 J = Mass moment of inertia reflected to the input shaft (including pinion assembly).  
 Specifications subject to change without notice.

# Micron TRUE Planetary® Gearheads

## XTRUE™

### True Planetary Gearheads

Performance Specifications									
Part Number	Ratio	20000 Hour Life				T <sub>peak</sub> Nm [in.-lb.]	J kg-cm <sup>2</sup> [in.-lb.-sec <sup>2</sup> *10 <sup>-4</sup> ]	Torsional Stiffness Nm/arc-min [in.-lb./arc-min]	
		T <sub>r</sub> (1000 rpm) Nm [in.-lb.]	T <sub>r</sub> (2000 rpm) Nm [in.-lb.]	T <sub>r</sub> (3000 rpm) Nm [in.-lb.]	T <sub>r</sub> (4000 rpm) Nm [in.-lb.]				
XT120 / XTA120	XT(A)120-003	3:1	90 [799]	74 [650]	65 [576]	59 [520]	298 [2639]	7.695 [68.107]	17.4 [154.0]
	XT(A)120-004	4:1	107 [948]	89 [790]	79 [697]	74 [650]	298 [2639]	5.949 [52.653]	17.4 [154.0]
	XT(A)120-005	5:1	99 [873]	81 [716]	71 [632]	65 [576]	298 [2639]	5.149 [45.573]	17.4 [154.0]
	XT(A)120-007	7:1	97 [855]	79 [697]	68 [604]	63 [558]	298 [2639]	4.413 [39.058]	17.4 [154.0]
	XT(A)120-010	10:1	87 [771]	79 [697]	74 [650]	69 [613]	298 [2639]	4.048 [35.828]	17.4 [154.0]
	XT(A)120-015	15:1	146 [1292]	119 [1050]	105 [929]	96 [846]	298 [2639]	4.748 [42.023]	17.4 [154.0]
	XT(A)120-020	20:1	169 [1496]	139 [1227]	124 [1097]	114 [1013]	298 [2639]	4.709 [41.678]	17.4 [154.0]
	XT(A)120-025	25:1	161 [1422]	130 [1152]	116 [1022]	106 [939]	298 [2639]	4.690 [41.510]	17.4 [154.0]
	XT(A)120-030	30:1	180 [1589]	146 [1292]	129 [1143]	119 [1050]	298 [2639]	3.949 [34.952]	17.4 [154.0]
	XT(A)120-040	40:1	187 [1654]	169 [1496]	150 [1329]	139 [1227]	298 [2639]	3.938 [34.854]	17.4 [154.0]
XT(A)120-050	50:1	179 [1580]	161 [1422]	142 [1254]	130 [1152]	298 [2639]	3.933 [34.810]	17.4 [154.0]	
XT(A)120-070	70:1	176 [1561]	159 [1403]	140 [1236]	128 [1134]	298 [2639]	3.929 [34.775]	17.4 [154.0]	
XT(A)120-100	100:1	120 [1059]	109 [966]	104 [920]	100 [883]	298 [2639]	3.927 [34.757]	17.4 [154.0]	
XT160	XT160-003	3:1	317 [2806]	257 [2277]	228 [2016]	209 [1849]	876 [7750]	23 [204]	50.5 [446.9]
	XT160-004	4:1	371 [3280]	305 [2695]	272 [2407]	251 [2221]	876 [7750]	15 [133]	50.5 [446.9]
	XT160-005	5:1	350 [3094]	284 [2509]	251 [2221]	230 [2035]	876 [7750]	14 [124]	50.5 [446.9]
	XT160-007	7:1	344 [3048]	278 [2463]	246 [2174]	225 [1989]	876 [7750]	15 [133]	50.5 [446.9]
	XT160-010	10:1	222 [1961]	198 [1756]	185 [1635]	175 [1552]	876 [7750]	12 [106]	50.5 [446.9]
	XT160-015	15:1	508 [4498]	417 [3689]	370 [3271]	339 [3001]	876 [7750]	15 [133]	50.5 [446.9]
	XT160-020	20:1	513 [4544]	481 [4256]	428 [3791]	395 [3494]	876 [7750]	15 [133]	50.5 [446.9]
	XT160-025	25:1	492 [4358]	460 [4070]	407 [3605]	374 [3308]	876 [7750]	15 [133]	50.5 [446.9]
	XT160-030	30:1	562 [4971]	508 [4498]	455 [4024]	417 [3689]	876 [7750]	12 [106]	50.5 [446.9]
	XT160-040	40:1	536 [4739]	513 [4544]	500 [4423]	481 [4256]	876 [7750]	13 [115]	50.5 [446.9]
XT160-050	50:1	515 [4553]	492 [4358]	479 [4237]	460 [4070]	876 [7750]	12 [106]	50.5 [446.9]	
XT160-070	70:1	509 [4507]	487 [4312]	474 [4191]	455 [4024]	876 [7750]	12 [106]	50.5 [446.9]	
XT160-100	100:1	306 [2704]	279 [2472]	265 [2342]	254 [2249]	876 [7750]	12 [106]	50.5 [446.9]	

All ratios in frame size 060, 070, 080, 090, 120 and 160 are available to ship in 24 hours through the Gearhead Express Program.

T<sub>r</sub> = Rated output torque at rated speed for specific hours of life.

T<sub>peak</sub> = Allowable momentary peak torque for emergency stop or heavy shock loading.

J = Mass moment of inertia reflected to the input shaft (including pinion assembly).

Specifications subject to change without notice.

True Planetary Gearheads

### Radial and Axial Load Ratings

#### XT040 / XTA050

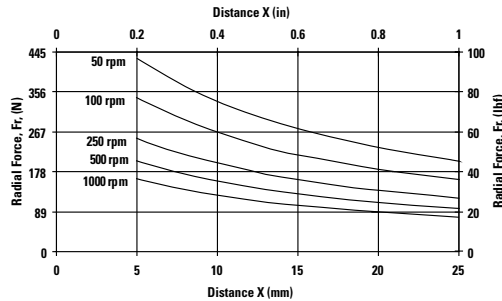
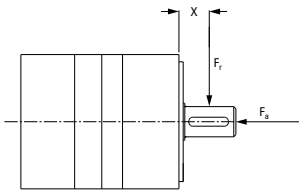

Speed rpm	Axial Load, $F_a$ N [lb <sub>f</sub> ]
50	737 [166]
100	585 [132]
250	431 [97]
500	342 [77]
1000	272 [61]

#### XT060 / XTA070

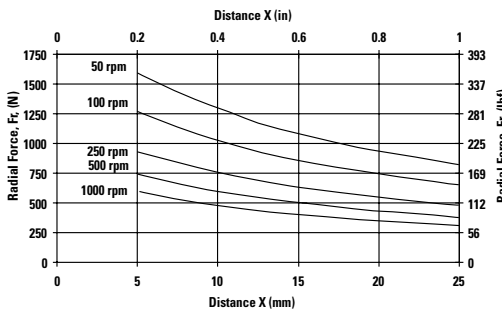
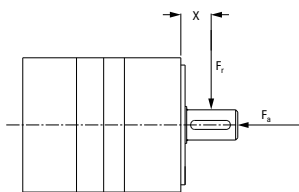

Speed rpm	Axial Load, $F_a$ N [lb <sub>f</sub> ]
50	2542 [571]
100	2017 [454]
250	1486 [334]
500	1180 [265]
1000	936 [211]

#### XT080 / XTA090

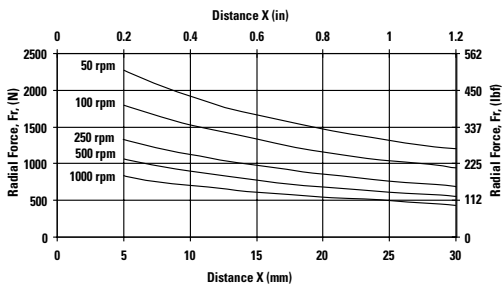
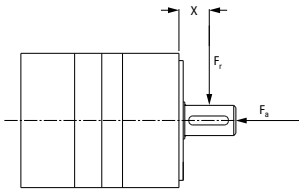

Speed rpm	Axial Load, $F_a$ N [lb <sub>f</sub> ]
50	3780 [850]
100	3000 [675]
250	2211 [497]
500	1755 [394]
1000	1393 [313]

#### XT120 / XTA120

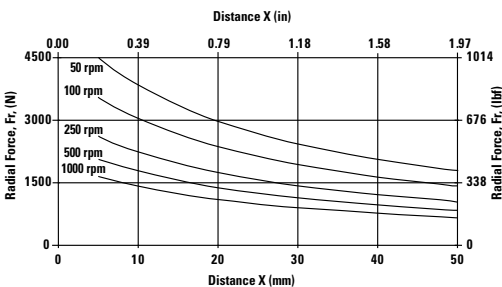
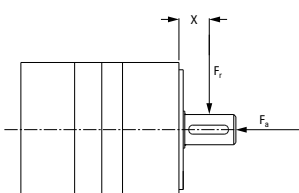

Speed rpm	Axial Load, $F_a$ N [lb <sub>f</sub> ]
50	6894 [1550]
100	5471 [1230]
250	4034 [907]
500	3203 [720]
1000	2540 [571]

#### XT160

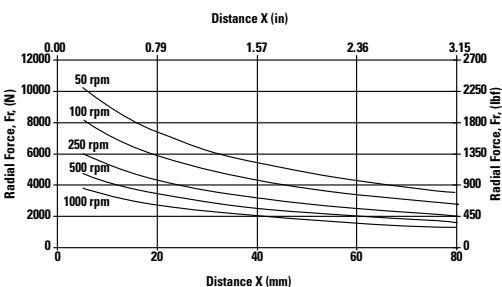
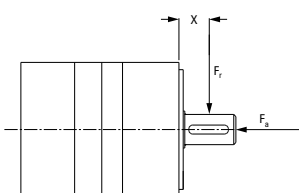

Speed rpm	Axial Load, $F_a$ N [lb <sub>f</sub> ]
50	14,122 [3175]
100	11,209 [2520]
250	8260 [1857]
500	6556 [1474]
1000	5204 [1170]

These graphs display the allowable radial load at a given distance (X) from the mounting surface based on an  $L_{10}$  life of 20,000 hours for the mean output speed.