











Linear Actuators

Linear actuators for industrial, mobile, medical, office and domestic applications.

THOMSON[®]

Linear Motion. Optimized.

		LIFTING COLUMNS				RODLESS			OTHER
	5	LA24	TC16	DMD	DMA	LM80-H	LM80-V	LM80-I	
									
	•/•/•	/•/•	•/•/•	•/•/•	•/•/•	•/•/•	•/•/•	•/•/•	<p>On the next pages you can find information on the following type of actuators:</p> <ul style="list-style-type: none"> • Non-driven • Rotary • Legacy • Custom
	better	best	best	better	better	better	better	better	
	/ 115 ³ , 230, 400 ²	/ 230, 400	24 /	12, 24, 36 /	/ 115 ³ , 230, 400 ²	12, 24 /	12, 24 /	12, 24 /	
	6800	6800	2000	6800	6800	2000 ⁴	2000 ⁵	2000 ⁵	
	60	60	19	60	60	110	110	110	
	610	600	400	610	610	1500	1500	1500	
	12	0	0	0	0	0	0	0	
	IP45	IP45	IP44	IP65	IP45	IP44	IP44	IP44	
	clevis	clevis/trunnion	base mount	base mount	base mount	T-slot	T-slot	T-slot	
	• ² / /•	• / /•	• ⁷ / /	• / /•	• / /•	• ⁷ / /•	• ⁷ / /•		
	•	•		•	•				
	•	•		•	•				
			•						
			•						
	• ³								
	•	•		• ²	• ²				
			•						
		•							
	•	•				•	•		
	26	28	30	32	34	36	38	40	
	DPDT Switch	DPDT Switch	DCG-180	AC-063	DPDT Switch	DCG-170	DCG-160	DCG-160	

³ Not available in Europe. ⁴ For horizontal operation only. ⁵ For vertical operation only. ⁶ At end of stroke only. ⁷ Trapezoidal screw.

Electrak 5

230 and 400 Vac - load up to 6800 N



Standard Features and Benefits

- Robust, strong and reliable
- Stainless steel extension tube
- Acme or ball screw models
- Overload clutch for mid and end of stroke protection
- Heavy duty motor with thermal switch
- Anti-coast brake for repeatable positioning on all ball screw models. Optional on acme screw models.
- Maintenance free

General Specifications

Parameter	Electrak 5
Screw type	acme or ball
Internally restrained	no
Manual override	no, optional
Dynamic braking	no
Holding brake acme screw models ball screw models	no, self-locking yes
End of stroke protection	overload clutch
Mid stroke protection	overload clutch
Motor protection	auto reset thermal switch
Motor connection	cable
Motor connector	no
Certificates	UL, CSA, CE
Options	<ul style="list-style-type: none"> • potentiometer • manual override

» Ordering Key - see page 68

» Glossary - see page 74

» Electric Wiring Diagram - see page 48

Performance Specifications

Parameter		Electrak 5
Maximum load, dynamic / static	[N]	
A •• -05A5 (acme screw)*		1100 / 11350
A •• -10A5 (acme screw)		2250 / 11350
A •• -20A5 (acme screw)		2250 / 11350
A •• -05B5 (ball screw)		2250 / 18000
A •• -10B5 (ball screw)		4500 / 18000
A •• -20B5 (ball screw)		4500 / 18000
A •• -21B5 (ball screw)		6800 / 18000
Speed, at no load / at maximum load	[mm/s]	
A •• -05A5 (acme screw)*		48 / 38
A •• -10A5 (acme screw)		30 / 18
A •• -20A5 (acme screw)		15 / 12
A •• -05B5 (ball screw)		61 / 37
A •• -10B5 (ball screw)		30 / 19
A •• -20B5 (ball screw)		15 / 12
A •• -21B5 (ball screw)		15 / 11
Available input voltages	[Vac]	
Single phase		230**
Three phase		400
Input frequency	[Hz]	
1 × 230 Vac model		50/60
3 × 400 Vac model		50
Standard stroke lengths	[inch]	4, 6, 8, 10, 12, 14, 16, 18, 20, 24
Operating temperature limits	[°C]	-25 – +65
Full load duty cycle @ 25 °C	[%]	25
Maximum on time	[s]	45
End play, maximum	[mm]	1,0
Restraining torque	[Nm]	11,3
Lead cross section	[mm ²]	1,5
Cable length	[mm]	600
Protection class		IP45

* Not possible with 400 Vac input voltage.

** 10 µF capacitor required to run the actuator, p/n 9200-448-003

Compatible Controls

Control model	See page
DPDT switch	50

Electrak 5

230 and 400 Vac - load up to 6800 N

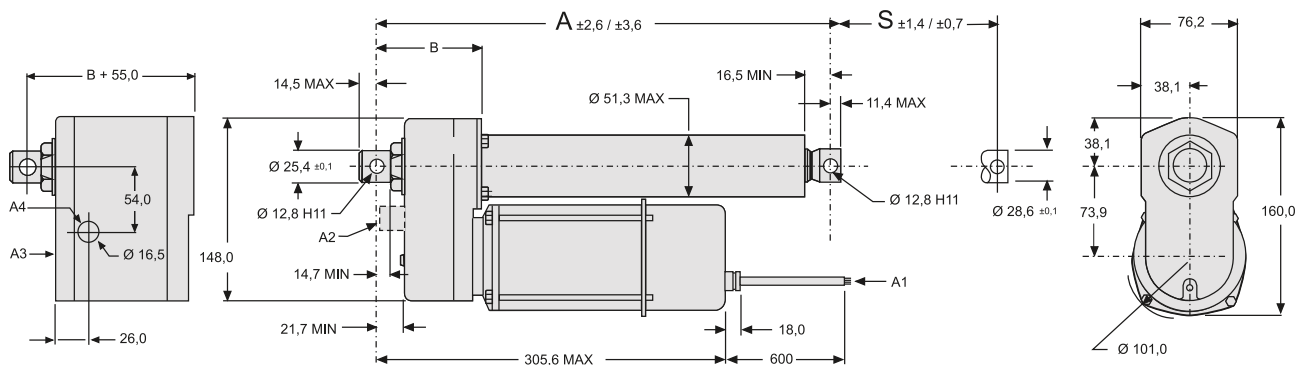

S: stroke, tolerance acme / ball screw
 A: retracted length, tolerance acme / ball screw
 A1: cable
 A2: manual override input (optional)
 A3: housing dimensions for potentiometer option
 A4: potentiometer cable output, cable length = min. 500 mm
 B: 86,1 mm

Stroke (S)	[inch (mm)]	4 (101,6)	6 (152,4)	8 (203,2)	10 (254,0)	12 (304,8)	14 (355,6)	16 (406,4)	18 (457,2)	20 (508,0)	24 (609,6)
Retracted length, acme screw models (A)	[mm]	262,3	313,1	363,9	414,7	465,5	567,1	617,9	668,7	719,5	821,1
Retracted length, ball screw models (A)	[mm]	302,3	353,1	403,9	454,7	505,5	607,1	657,9	708,7	759,5	861,1
Add on length for potentiometer*	[mm]	55,0	55,0	55,0	55,0	55,0	55,0	55,0	55,0	55,0	55,0
Weight, acme screw models	[kg]	5,9	6,1	6,3	6,5	6,7	6,9	7,1	7,3	7,5	7,8
Weight, ball screw models	[kg]	6,5	6,7	6,9	7,1	7,3	7,5	7,7	7,9	8,1	8,4
Add on weight for potentiometer*	[kg]	1,3	1,3	1,3	1,3	1,3	1,3	1,3	1,3	1,3	1,3
Potentiometer resistance change*	[ohm/mm]	39	39	39	39	20	20	20	20	20	10

* Potentiometer is optional (NPO, BPO option)

Performance Diagrams

Acme Screw Models
Speed and Current vs. Load

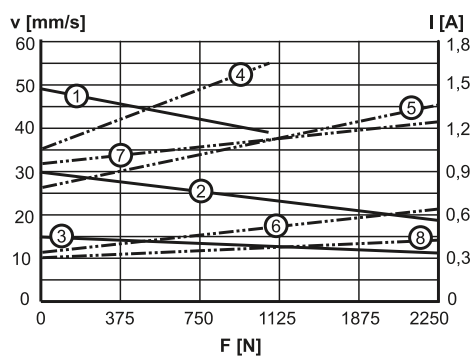

V: speed
 I: current
 F: load
 1: speed A22 -05A5
 2: speed A•• -10A5
 3: speed A•• -20A5
 4: current 230 Vac, A22-05A5
 5: current 230 Vac, A22-10A5
 6: current 400 Vac, A42-10A5
 7: current 230 Vac, A22-20A5
 8: current 400 Vac, A42-20A5

Ball Screw Models
Speed and Current vs. Load

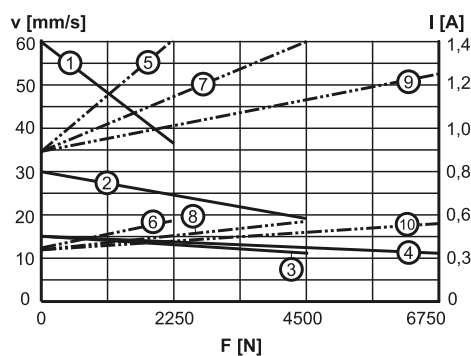

V: speed
 I: current
 F: load
 1: speed A22-05B5, A42-05B5
 2: speed A22-10B5, A42-10B5
 3: speed A22-20B5, A42-20B5
 4: speed A22-21B5, A42-21B5
 5: current 230 Vac, A22-05B5
 6: current 400 Vac, A42-05B5
 7: current 230 Vac, A22-10B5, A22-20B5
 8: current 400 Vac, A42-10B5, A42-20B5
 9: current 230 Vac, A22-21B5
 10: current 400 Vac, A42-21B5

Electrical Wiring Diagrams

AC-actuators

Electrak 5, LA24 and DMA - 1 × 230 Vac

Without anti coast brake*

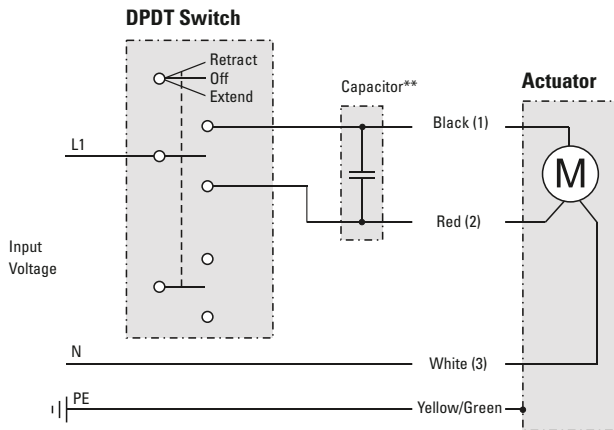

With anti coast brake*

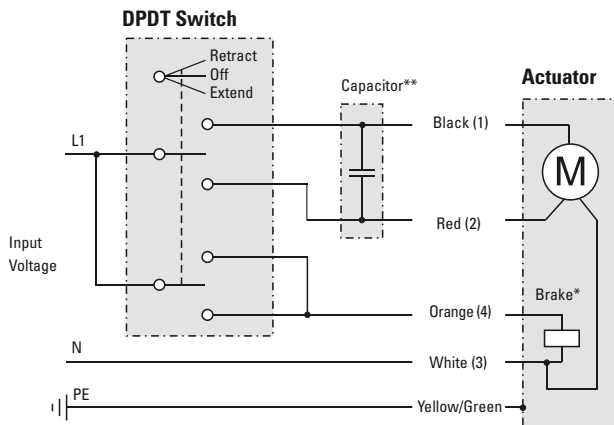

* Anti coast brake is standard on Electrak 5 / LA24 for ball screw models and optional for acme screw models. On DMA there are no anti coast brake on acme models while ball screw models always are equipped with an anti coast brake.

** 10 µF capacitor required to run the actuator, p/n 9200-448-003.

Leads can be either color or number marked. Connect black (1) lead to L1 and white (3) lead to N (neutral) to retract the actuator. Change L1 from lead black (1) to lead red (2) to extend the actuator. If the actuator is equipped with an anti coast brake, release the brake by connecting orange (4) lead lead to L1.

Electrak 5, LA24 and DMA - 3 × 400 Vac

Without anti coast brake*

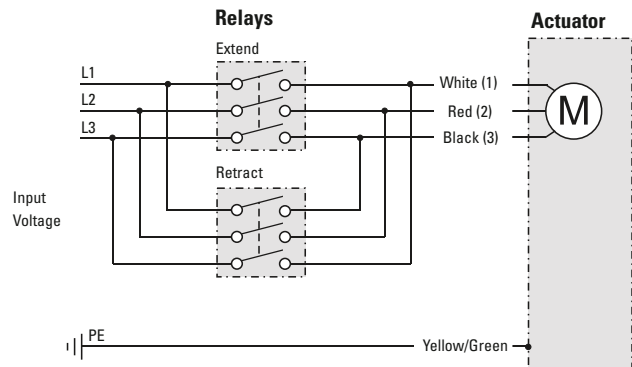

With anti coast brake*

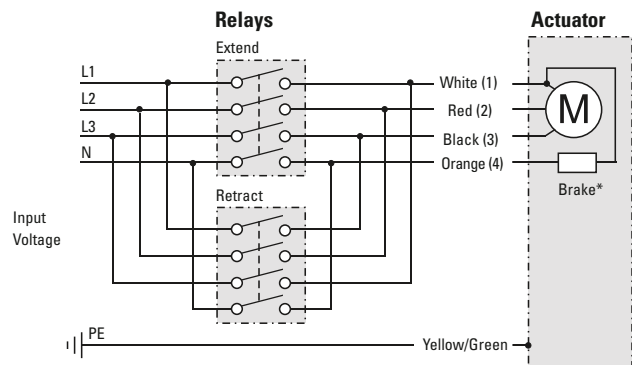

* Anti coast brake is optional on Electrak 5 / LA24 on both acme and ball screw models. On DMA there are no anti coast brake on acme models while ball screw models always are equipped with an anti coast brake.

Leads can be either color or number marked. Connect white (1) lead to L1, red (2) lead to L2 and black (3) lead to L3 to extend the actuator. Change the places of white (2) lead and black (3) to retract the actuator. If the actuator is equipped with an anti coast brake, release the brake by connecting orange (4) lead lead to N (neutral).

Ordering Keys

Electrak AC-actuators

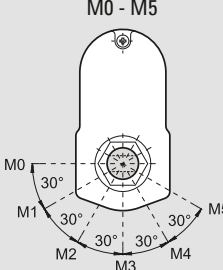
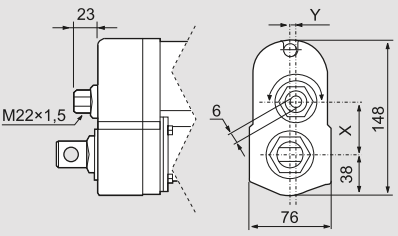
Electrak 5														
1	2	3	4	5										
A22 -	20B5 -	04	M0	BPO										
<p>1. Input voltage A22 - = 1 × 230 Vac A42 - = 3 × 400 Vac</p> <p>2. Dynamic load capacity, screw type and maximum speed 05A5 - = 1100 N, acme, 54 mm/s¹ 10A5 - = 2250 N, acme, 30 mm/s 20A5 - = 2250 N, acme, 15 mm/s 05B5 - = 2250 N, ball, 61 mm/s 10B5 - = 4500 N, ball, 30 mm/s 20B5 - = 4500 N, ball, 15 mm/s 21B5 - = 6800 N, ball, 15 mm/s</p> <p>3. Stroke 04 = 4 inch (101,6 mm) 06 = 6 inch (152,4 mm) 08 = 8 inch (203,2 mm) 10 = 10 inch (254,0 mm) 12 = 12 inch (304,8 mm) 14 = 14 inch (355,6 mm) 16 = 16 inch (406,4 mm) 18 = 18 inch (457,2 mm) 20 = 20 inch (508,0 mm) 24 = 24 inch (609,6 mm)</p>	<p>4. Rear adapter hole position² M0 = adaptor at 0° (standard position) M1 = adaptor at 30° M2 = adaptor at 60° M3 = adaptor at 90° M4 = adaptor at 120° M5 = adaptor at 150°</p> <p>5. Options³ N = no option B = anti coast brake³ NPO = potentiometer NHW = manual override⁴ BPO = anti coast brake and potentiometer³ BHW = anti coast brake and manual override^{3/4}</p> <p>¹05A5 - not possible with 400 Vac input voltage. ²Definition of rear adapter hole positions.</p> 	<p>³Ball screw versions must always be ordered with an anti coast brake while acme versions can be ordered with or without an anti coast brake.</p> <p>⁴Dimensions for manual override option.</p>  <table border="1"> <thead> <tr> <th>Model</th> <th>X</th> <th>Y</th> </tr> </thead> <tbody> <tr> <td>05A(B)5 -</td> <td>49,6</td> <td>0,0</td> </tr> <tr> <td>10A(B)5 -</td> <td>43,3</td> <td>5,2</td> </tr> <tr> <td>20(21)A(B)5 -</td> <td>38,9</td> <td>0,0</td> </tr> </tbody> </table>	Model	X	Y	05A(B)5 -	49,6	0,0	10A(B)5 -	43,3	5,2	20(21)A(B)5 -	38,9	0,0
Model	X	Y												
05A(B)5 -	49,6	0,0												
10A(B)5 -	43,3	5,2												
20(21)A(B)5 -	38,9	0,0												

Glossary

A – C

Acme Screw

Acme screws are self locking and will not backdrive. They also withstand vibration and shock better than ball or worm screws and are used for applications with these characteristics. Also see “lead screw”.

Actuator Housing

The actuator housing provides environmental protection for the internal components and may also be a structural member of the actuator.

Adapters

The front and rear adapters are the connection points for mounting most Thomson actuators. The front adapter is usually a cross hole but optionally may be a tapped hole, threaded rod, or universal rod end. The rear adapter may be cast into the actuator housing or held in place with a nut.

Adjustable End of Stroke Limit Switches

The adjustable end of stroke limit switches may be moved to positions inside the full stroke of the actuator and will shut off the actuator when it reaches the limit switch. Also see “end of stroke limit switches”.

Anti Coast Brake/Electrical Brake

Depending on the load, AC ball screw actuators may coast to a stop when power is removed. This overrun is eliminated by an anti coast brake or an electrical brake. The anti coast brake (pawl type) will allow up to one revolution of the motor after power is removed. They are used on the Electrak 5 and PPA-AC with anti coast brake. An electrical brake (electrically released) operates much faster after power is removed and allow less coast than the pawl type. Electrak 205 and the PPA-AC with electrical brake use this type of brake. Also see “brake”.

Anti Rotation Mechanism

A feature available on some actuators that resolves the restraining torque within the actuator. The extension tube will not rotate on actuators with this feature.

Auto Reset Thermal Switch

An auto reset thermal will switch off the motor if it becomes too warm which means that the motor has exceeded its maximum allowed duty cycle. When the motor has cooled of the switch will close again automatically and the motor will start to run if power still is being applied to it. Also see “duty cycle”.

Ball Screw

Ball screws are highly efficient and are used for high loads and speeds. Also see “lead screw”.

Brake

Actuators using a acme or worm screw are inherently self-locking while ball screw driven actuators are not. To prevent ball screw actuators from backdriving they incorporate an anti backdriving brake (holding brake). Ball screw actuators with an AC motor can also be equipped with an anti coast brake. Also see “anti coast brake/electrical brake” and “holding brake”.

Capacitor

The AC actuators use permanent split capacitor motors and require the use of a start/run capacitor in the control circuit to operate. The controls for the AC actuators have the capacitor included in the control. For customer supplied controls, a separate capacitor is required and the part number is included on the actuator product page.

Certificates

CE certification and UL listing are the two main third party approvals available for actuators. Most of the AC actuators are UL listed as standard and UL has no standard for DC actuators under 48 Vdc. All actuators sold in the EU are CE certified while some actuators sold outside of the EU may not be. If you order your actuator outside of the EU and need a CE certification, contact the factory to verify availability and be sure to include the request on your order.

Controls

Controls can be external to the actuator and provide the actuator with the correct voltage, have either membrane or pendant operators and some have position indicators. The Pro series also has internal controls that continuously monitor the operation of the actuator.

Cover Tube

The cover tube provides protection for the lead screw and provides protection and support for the extension tube. For the Electrak 100 and PPA and as an option on the Electrak 205 actuators, the cover tube also provides the rear mounting connection.

Customization

Even the most versatile actuator may not always suit all applications. But whatever your need is, our engineers are ready to help you to customize the actuators according to your requirements. We build more exclusive actuators than anyone else and have decades of experience of producing actuators to meet special needs.

Glossary

D – G

Duty Cycle

$$\text{Duty cycle} = \frac{\text{on time}}{(\text{on time} + \text{off time})}$$

Example: 15 seconds on, 45 seconds off

$$\frac{15 \text{ s}}{(15 \text{ s} + 45 \text{ s})} = 25\% \text{ duty cycle}$$

The duty cycle is a function of the maximum rated load and the ambient temperature. Ambient temperatures above the stated will affect the duty cycle negatively while lower temperatures and/or lower load will affect it positively. Review the following duty cycle versus load charts when higher duty cycles are needed for Electrak 1, Electrak 10 or DMD actuators.

Electrak 1, Electrak 1SP

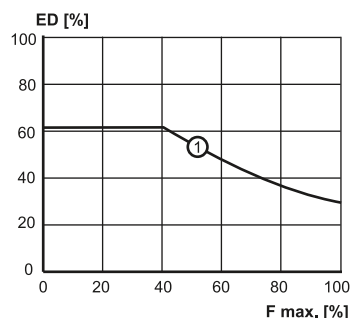

ED: duty cycle in percent at 25° C

F max: percent of maximum rated load

1: all Electrak 1 and Electrak 1SP models

Electrak 10, DMD

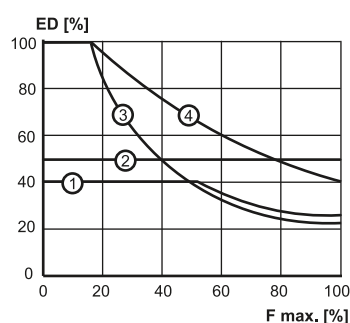

ED: duty cycle in percent at 25° C

F max: percent of maximum rated load

1: D •• -10A5 (acme screw) 3: D •• -05B5 (ball screw)

2: D •• -20A5 (acme screw) 4: D •• -20B5 (ball screw)

Dynamic Load

The dynamic load rating is how much load the actuator will move when power is applied. Also see "load rating".

Dynamic Braking

Dynamic braking is a feature which short circuits the motor windings at power off resulting in a shorter coasting distance

before the actuator comes to a complete stop. Dynamic braking can be accomplished on other dc actuators by wiring the control to short the motor leads when power is removed.

Electronic Limit Switches (ELS)

ELS stands for Electronic Limit Switches and it is a current sensing function used in some actuator control models. The ELS senses the current and if the current exceeds a pre-set level the control cuts the power to the motor. This function can be used to detect and stop at the ends of the actuator stroke or to stop the actuator if it runs into an obstacle.

Electronic Load Monitoring (ELM)

A built-in microprocessor inside the actuators continuously monitors the performance of the actuator. The microprocessor will stop the movement at the end of stroke, in case of mid stroke stall, at overload conditions or if the duty cycle is too high. It also eliminates the need of a clutch and provides dynamic braking.

Encoder Feedback

Encoders provide a digital output signal that can be used to determine the position of the extension tube. An encoder equipped actuator must return to a "home" position if power is removed and restored in order to reset its starting point. Also see "potentiometer feedback".

End of Stroke Limit Switches

End of stroke limit switches are switches that are incorporated in some actuator models, either as standard or as an option, that will shut off power when the end of stroke is achieved. Also see "fixed end of stroke limit switches" and "adjustable end of stroke limit switches".

End Play (Backlash)

The stack up of tolerances within the lead screw assembly and gearing allowing some linear movement of the extension tube without rotating the motor. Typical end play or backlash varies by model. The range is 0,3 to 2,0 mm.

Extension Tube

The extension tube slides in and out of the actuator and is connected via the front adaptor to the load being moved or positioned.

Fixed End of Stroke Limit Switches

The fixed end of stroke limit switches allow the full stroke of the actuator to be used and will shut off power when the end of stroke is achieved. Also see "end of stroke limit switches".

Glossary

H – Life

Holding Brake

The Electrak 1, 2, 050, 150 and some Pro series incorporate an acme screw which is inherently self-locking while Electrak 5, 10, 100, 205 and the high load Pro series actuators have a ball screw drive incorporating an anti backdriving brake (holding brake) that engages when the actuator has come to a complete stop. Also see “brake”.

Input Voltage

The nominal voltage required to operate the actuator. All actuators will accept at least a $\pm 10\%$ variation of the nominal voltage but a change in the voltage will result in a change of the speed of dc actuators. Controls are available that accept 115 or 230 Vac input and provide 24 Vdc output to operate 24 Vdc actuators.

Installation Instructions

Each actuator has an installation manual to answer typical questions about mounting and wiring the actuators.

Lead Screw

Actuators use four different types of lead screws depending on the configuration and load requirements of the actuator. Ball screws are highly efficient and are used for high loads and speeds. Acme, worm and trapezoidal screws are self locking and will not backdrive. Acme and trapezoidal screws withstand vibration and shock better than the other and are used for applications with these characteristics.

Lifetime Expectancy

Life is a function of load, stroke length and how often the overload clutch is operated. The following life versus load charts will provide a life estimate for your particular application. Contact customer service for more information or for information on other actuator models.

Electrak 1, Electrak 1SP

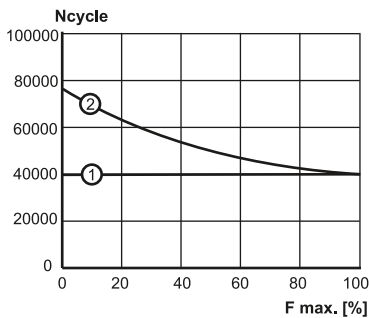

Ncycle: life in number of cycles (one cycle = extend and retract)
F max: percent of maximum rated load
1: Electrak 1 when using the internal limit switches for end of stroke
2: both models when using external limit switches for end of stroke

Electrak 10, DMD - Acme Screw Models

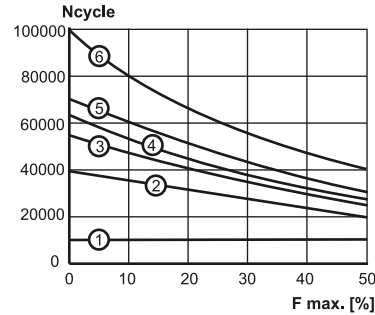

Ncycle: life in number of cycles (one cycle = extend and retract)
F max: percent of maximum rated load
1: all models using the clutch at end of stroke
2: D •• -20A5, 12 inch stroke
3: D •• -20A5, 8 inch stroke
4: D •• -10A5, 12 inch stroke
5: D •• -10A5, 8 inch stroke and D •• -20A5, 4 inch stroke
6: D •• -10A5, 4 inch stroke

Contact customer service if you need life estimates for loads above 1125 N or stroke lengths above 12 inch.

Electrak 10, DMD - Ball Screw Models

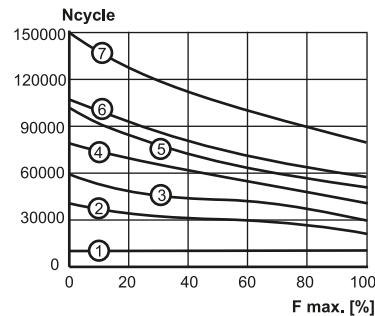

Ncycle: life in number of cycles (one cycle = extend and retract)
F max: percent of maximum rated load
1: all models using the clutch at end of stroke
2: D •• -10B5 and D •• -20B5, 12 inch stroke
3: D •• -10B5 and D •• -20B5, 8 inch stroke
4: D •• -05B5, 12 inch stroke
5: D •• -10B5 and D •• -20B5, 4 inch stroke
6: D •• -05B5, 8 inch stroke
7: D •• -05B5, 4 inch stroke

Contact customer service if you need life estimates for loads above 4500 N or stroke lengths above 12 inch.

Glossary

Lift – 0

Electrak 5, DMA - Ball Screw Models

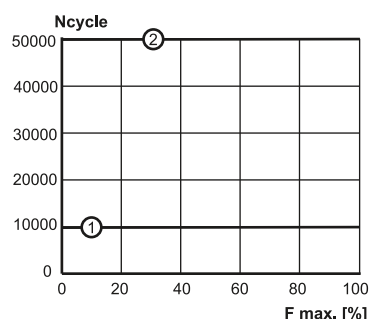

Ncycle: life in number of cycles (one cycle = extend and retract)

F max: percent of maximum rated load

1: all models using the clutch at end of stroke

2: all models using the anti-coast brake at end of stroke only

The above chart is only valid for ball screw models with rated load up to 4500 N and stroke lengths up to 12 inch. Contact customer service if you need life estimates for acme screw models or for higher loads or longer stroke lengths.

Lifting Columns

Lifting columns provide a stable base for adjusting the height of tables or platforms. The column provides both the lifting force and the ability to resolve high moment forces from off axis loads.

Linear Actuators

Actuators providing a linear thrust via an extension tube to lift, lower, push, pull or position a load.

Load Rating

The load rating is the minimum amount of force the actuator will provide during its lifetime. The load rating of all rod style actuators is the same for both compression and tension loads. Also see "dynamic load", "static load" and "tension and compression load".

Manual Override (Hand Wind)

Allows manual operation of the actuator in both directions in case of a power failure. The actuator accepts a standard hexagon key to rotate the motor in either direction. Optional on some models.

Maximum On Time

The maximum amount of time an actuator may operate without stopping to "cool off". For high load and long stroke actuators this may be one extend and retract cycle. The actuator should not exceed 25% duty cycle at full rated load. If no maximum on time is stated then the maximum on time are equal to one full cycle at the maximum dynamic load for the actuator in question.

Mounting

Electrak actuators are quickly and easily mounted by slipping pins through the holes on each end of the unit and into brackets on the machine frame and the load. Electrak 100 units must be mounted by the cover tube and a swivel rod end. PPA actuators are mounted by the rear trunnions on the cover tube and the clevis on the extension tube. The Electrak 205 can be mounted by either the rear clevis or by a tube mount. 12,7 mm diameter solid pins (6,35 mm solid pins for Electrak 1 and 050) provide maximum holding strength and a retaining or cotter pin on each end will prevent the solid pin from falling out of its mounting bracket. Roll or spring type mounting pins should be avoided. The mounting pins must be parallel to each other as shown below (Fig. a). Pins which are not parallel may cause the actuator to bind. The load should act along the axis of the actuator since off center loads may cause binding (Fig. b).

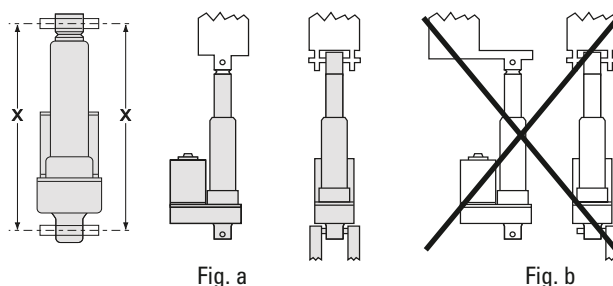

Fig. a

Fig. b

Non-driven Actuators

Actuators supplied without a motor and driven manually or by a customer supplied motor.

Operating and Storage Temperature

The operating temperature is the range in which the actuator may be safely operated. For the high end of the range, the duty cycle will be lower than 25%. All actuators can be stored or transported at the same temperature as the operating temperature. Contact customer support if the operating temperature will be exceeded during storage or transportation.

Output Voltage

Output voltage is the voltage from the control to run the actuator. The controls for dc actuators have 24 Vdc output. The controls for ac actuators have either 115 or 230 Vac output.

Overload Clutch

Electrak 050, 2, 5, 10, 100, 205 and PPA series linear actuators are protected by a load limiting mechanical clutch which prevents the motor from stalling at either end of the actuator stroke. It will also slip when the factory-set load limit is exceeded. The clutch is a ball detent design, assuring a consistent slip point and long life.

Glossary

P – Sp

Potentiometer Feedback

Potentiometers provide an analog output signal that can be used to determine the position of the extension tube. A potentiometer will “remember” its position if power is removed and restored. All potentiometers are set to a minimum value on full retract except for the EU versions of Electrak 5 and Electrak 10 where the minimum value are set on full extend. Also see “encoder feedback.”

Protection Class

The protection class refers to the environmental rating of the enclosure. The first digit applies to airborne contaminants and the second digit to water/moisture.

- IP33: protected against the penetration of solid objects with a diameter greater than 12 mm and against direct sprays of water up to 60 degrees from vertical.
- IP44: protected against the penetration of solid objects with a diameter greater than 1 mm and against water sprayed from any direction.
- IP45: protected against the penetration of solid objects with a diameter greater than 1 mm and low pressure water jets from any direction.
- IP51: protected from dust and vertical dripping water/condensation.
- IP52: protected from dust and dripping water/condensation falling at an angle up to 15 degrees from vertical.
- IP56: protected from dust and high pressure water jets from any direction.
- IP65: dust tight and protected against low pressure water jets from any direction.
- IP66: dust tight and protected against high pressure water jets from any direction.
- IP67: dust tight and protected against the effect of immersion in water between 150 mm (5.9 inch) and 1 meter (39.4 inch).

Pulse Width Modulation (PWM)

Pulse width modulation control works by switching the power supplied to the motor on and off very rapidly. The DC voltage is converted to a square-wave signal, alternating between fully on and zero, giving the motor a series of power “kicks”. If the switching frequency is high enough, the motor runs at a steady speed due to its fly-wheel momentum. By adjusting the duty cycle of the signal (modulating the width of the pulse, hence the “PWM”), the time fraction it is “on”, the average power can be varied, and hence the motor speed. All DC actuators can be speed controlled by PWM within certain limits without any adjustments except for the Pro series that due to the internal electronics must have a steady power supply.

Restraining Torque

The torque which is developed between the clevis on the extension tube and rear mount(clevis or trunnion) when the unit

extends or retracts and ratchets the clutch (Fig. c).

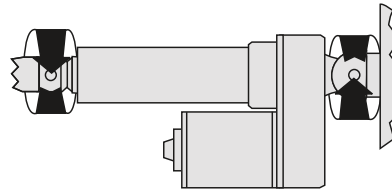

Fig. c

Rodless Actuators

Rodless actuators provide support for the load as well as thrust. The load is supported and moved by a carriage on the actuator rather than pushed or pulled by an extension rod. Rodless actuators are ideal for applications requiring long strokes (up to 1500 mm), high speeds (up to 110 mm/s), movement of the load within the shortest envelope possible or the load supported by the actuator.

RoHS Compliance

All actuators, controls and accessories sold in the EU are RoHS compliant unless otherwise stated, while products sold outside of the EU may not be. If you order an actuator outside of the EU and need it to be RoHS compliant, contact the factory to verify availability and be sure to include the request on your order.

Rotary Actuators

Actuators providing a rotary output to position a load, turn a winch, or rotate a gear or sprocket.

Service and Maintenance

Actuators are generally maintenance free. The Electrak 2, 5, 10, 100, 205 and Pro series have repair kits available from your local distributor or OEM.

Sizing and Selection

The Thomson web site www.thomsonlinear.com includes an online tool that can be used to walk through the decision process for picking the best actuator and to get the ordering data for your choice.

Speed

DC actuators have a direct load/speed relationship. As the load increases, the speed of the dc actuators decreases. There are curves on each product page to show the speed from no load to full rated load. AC actuators have very little speed fluctuations based on load but there are load/speed curves on all the ac actuator product pages.

Spline Safety Function

An optional safety function on the rodless actuator (LM80) that will stop downward motion in case the carriage (the moving

Glossary

Sp – W

member) collides with an obstacle. The motor will keep running but the carriage will stand still and not pull down on the obstacle. When reversing the motor rotation the carriage will automatically start to move upwards again.

Static Load

The static load rating is how much load the actuator will hold with power off. The static load rating is normally twice the dynamic load rating. Also see “load rating”. If nothing else is stated the static load rating is for the actuator extension tube being fully retracted. The static load rating will decrease as the tube extends.

Synchronous Operation

Motor speed cannot be controlled with enough precision to ensure that the actuators will remain synchronized and a binding effect could take place. Non-driven actuators may be mechanically linked and thereby synchronized. Actuators equipped with an encoder can also be synchronized using controls designed for synchronous operation.

Tension and Compression Load

A tension load tries to stretch the actuator and a compression load tries to compress the actuator (Fig. d). Most actuators can manage the same tension and compression load. Also see “load rating”.

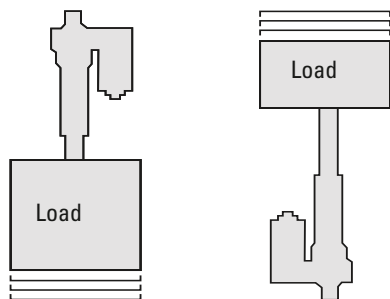

Fig. d

Trapezoidal Screw

Screw type with similar characteristics as an acme screw. This type of screw is used in TC16 and LM80. Also see “acme screw” and “lead screw”.

Vent Tube

The Electrak 050 and 150 have a breather tube in the wiring harness to allow the actuator to operate without creating a vacuum and drawing water through the seals on the cover tube.

Voltage Drop

Long leads/cables between the power source and the actuator will result in a voltage drop for DC units. This voltage drop can be avoided by sizing the leads in accordance with the following

www.thomsonlinear.com

lead

cross section selection table. The table is based on an ambient temperature of 30 °C or less. A higher ambient temperature may result in the need for a greater lead cross section.

Lead Cross Section Selection Table [mm²]

Current draw [A]	Cable length [m]	Actuator input voltage [Vdc]		
		12	24	36
0 - 10	0 - 3	1,5	1,5	1,5
	3 - 6	2,5	1,5	1,5
	6 - 10	4	1,5	1,5
10 - 15	0 - 3	1,5	2,5	1,5
	3 - 6	2,5	2,5	1,5
	6 - 10	4	2,5	1,5
15 - 20	0 - 3	2,5	-	-
	3 - 6	4	-	-
	6 - 10	6	-	-
20 - 28	0 - 3	4	-	-
	3 - 6	6	-	-
	6 - 10	10	-	-
28 - 35	0 - 3	6	-	-
	3 - 6	6	-	-
	6 - 10	10	-	-

Worm Screw

Worm screws are self locking and will not backdrive. This type of screw is used in Electrak 050. Also see “lead screw”.

Application Data Form

Worksheet

Application Data Form*		
Submitted by:	Phone:	Date:
1. Company name	20. Do you need any special retracted length (cross hole c/c in mm)?	
2. Street address	21. Is anti-rotation of the extension tube required (yes/no)?	
3. City-state, zip	22. What is the input voltage?	
4. Contact name	23. Do you need any of the optional features of the actuator?	
5. Phone	24. How will the actuator be connected (standard or special cabling)?	
6. Fax	25. Is mating connector required if connector is included in the actuator?	
7. E-mail	26. Do you need any special paint or finish?	
8. What is the estimated annual volume?	27. Is manual override necessary?	
9. What is the target price?	28. What are the environmental conditions (dusty, outdoors, wash down)?	
10. What is the current or alternative solution?	29. What is the operation temperature range in Celsius?	
11. How much load is moved in Newton?	30. What is the duty cycle (on-time / on-time + off-time) in seconds?	
12. How much load do you need to hold in Newton?	31. Do you need any certificate (UL, CE, etc.)?	
13. How will the actuator be mounted (horizontal/vertical)?	32. Do you require any print (dwg, dxf, faxed)?	
14. Is the load trying to stretch or/and compress the actuator?	33. Describe any additional requirements (packaging, labeling, etc.)	
15. What speed do you want the actuator to move in mm/s?		
16. What is the life of the unit in cycles (one cycle = extend and retract)?		
17. What is the stroke length?		
18. How will the actuator be mounted to the extension tube?		
19. How will the actuator be mounted to the rear adaptor?		

* Please enter all fields in the form and send it and any drawing to customer service by mail or fax. See the back of the catalog for the nearest location.